

PRODUCT INTRODUCTION

The Bianco NXT Summit Series Drive Controller Kits are an all-in-one solution designed to achieve advanced control, enhanced protection and optimal energy efficiency with the Bianco NXT range of Variable Frequency Drives.

Featuring the latest touch-screen technology and an intuitive user-friendly menu, these kits provide easy access to all the information you need.

SUMMIT SERIES VMS solutions are designed for performance, reliability and ease of use.

PUMP TECHNICAL DATA

RATED FLOW [M3/H]	32 m ³ /hr per pump
MAX. FLOW – PUMP SET	84 m ³ /hr
MAX. HEAD – PUMP SET	68.1 m
WORKING AIR TEMP	0°C – 40°C
LIQUID TEMPERATURE	-15°C – 120°C
HIGHEST EFFICIENCY	72.9%
MAXIMUM PUMP PRESSURE	37 bar
NET WEIGHT (KG)	94.6 kg

RATED VOLTAGE	Three phase 415V +10% -6%
RATED CURRENT	14.4 A
MOTOR POWER (KW)	7.5kW 2-pole
MOTOR IP RATING	IP55
MOTOR INSULATION	Class F
MOTOR EFFICIENCY STD	I.E.3
MOTOR EFFICIENCY	90.1%
COS Ø	0.88
MECHANICAL SEAL	SVH-L-22
PUMP FLANGE SIZE	DN65
MANIFOLD OUTLET SIZE	Dual 100mm / DN100 Flange



Image illustrative only

INCLUDES

- Galvanised dual-pump base
- 2 x VMS Pumps
- 2 x NXT Drives (Variable Frequency Drive)
- 4-20mA/10bar Pressure Transducer
- Stainless Steel Counter Flanges
- Gaskets to suit Counter Flanges
- Watermarked Spring Check Valve
- Manifold (304 Stainless Steel)
- 30bar Liquid-filled Pressure Gauge
- Outlet-side SS Isolation Valve
- BPT-18 10bar-rated Pressure Tank with 304 SS 25mm isolating valve

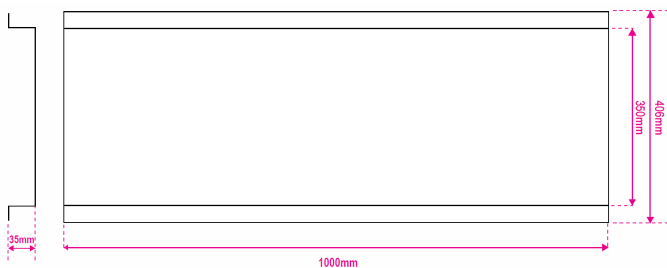

Base 1000 x 406mm x 35mm high

BIA-DRIVE3-75



PRODUCT DETAILS

The NXT DRIVE Series are a range of pump-specific Variable Frequency Drives designed for the Australasian market with both the end-user and the technician in mind.

Featuring a full-colour, touch-screen interface for clear, concise system information, fault codes and protection notices, with a handy setup wizard so you're always in control. NXT DRIVE is both simple to set up and use.

Perfect for achieving constant pressure management of a single pump with advanced control, enhanced protection and optimal energy efficiency.

FEATURES

- Control and protect pumps up to 7.5 kW (17.0 Amps)
- Variable frequency control to achieve constant pressure control
- Minimise wasted energy and reduce the need for large pressure tanks
- 'Soft-start' with low motor start current
- Flow, pressure and current protections
- RS485 comms
- 25 plain-language fault messages
- Provides protection from dry run, high and low voltage, input and output short circuits, high and low water pressure, input and output phase failure, high temperature and sensor faults
- 24V, 10V and 5V supply circuits
- Digital and analogue (voltage or current) inputs
- Relay and analogue outputs
- Multi-functional terminals

Three Phase 415VAC IN / Three Phase 415VAC OUT

TECHNICAL DATA

INPUT VOLTAGE	3ph 415VAC -10% +5%
INPUT FREQUENCY	50/60Hz 5% fluctuations
OUTPUT VOLTAGE	3ph 415VAC
OUTPUT FREQUENCY	0 – 200Hz
OUTPUT RATING	17.0A / Nominal 7.5kW
SPEED HOLDING PRECISION	±1%
INGRESS PROTECTION	IP54
OPERATING TEMPERATURE	-10°C to +40°C



SINGLE PUMP HYDRAULIC CURVE

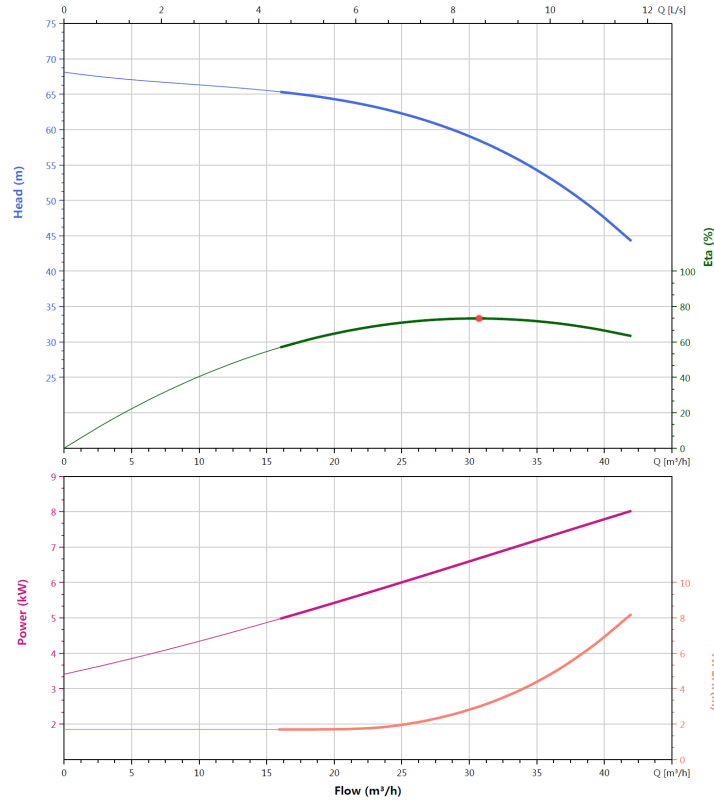

VFD CURVE

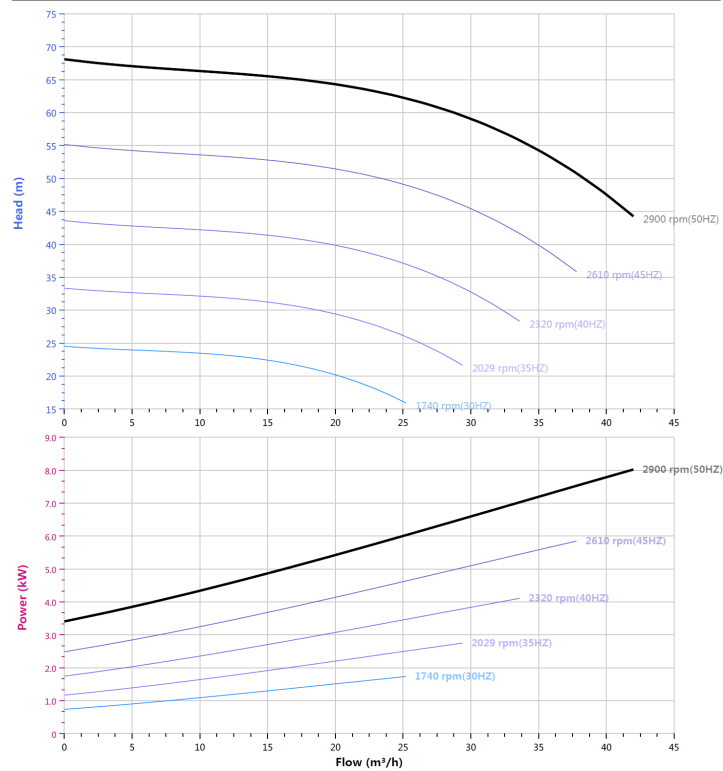

DUAL PUMP HYDRAULIC CURVE

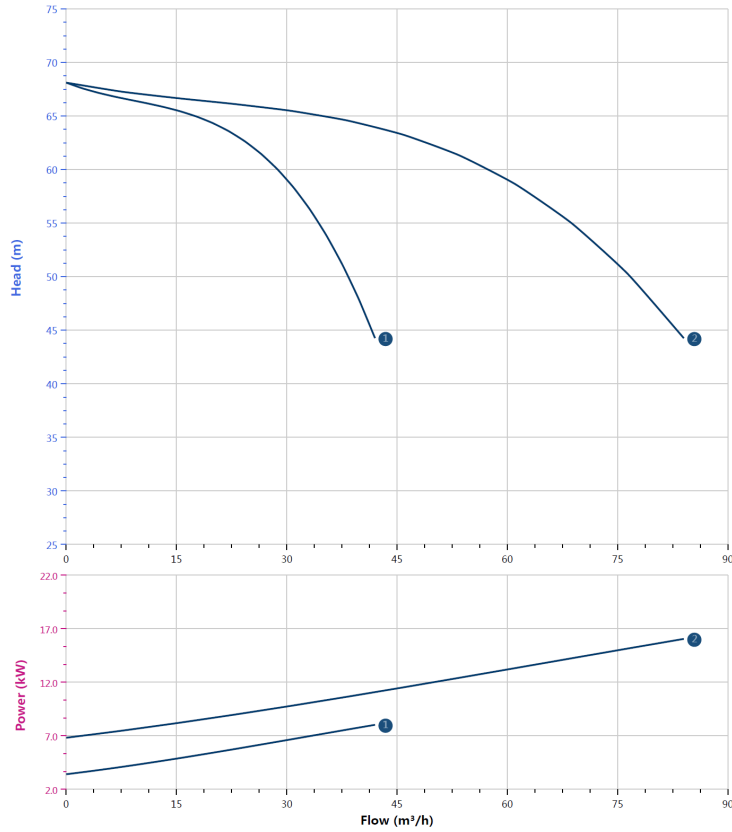

CUTAWAY

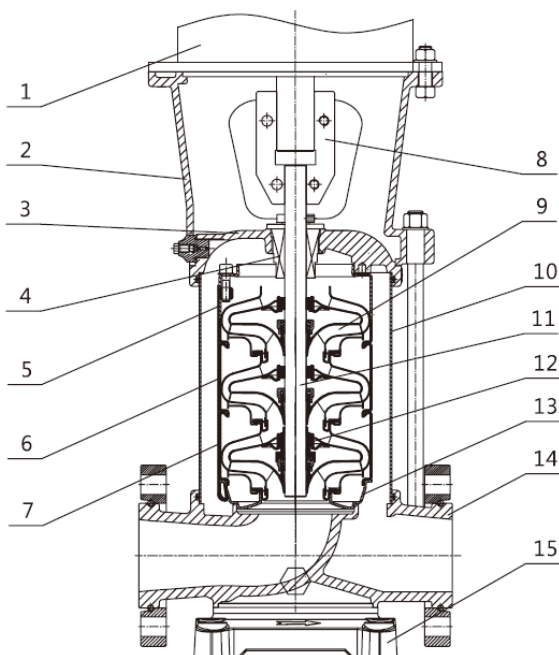

1	Motor	/
2	Bracket	Ductile Cast Iron
3	Seal Base	Stainless / Ductile Cast Iron
4	Mechanical Seal	SVH-L-22
5	Top Diffuser	Stainless Steel
6	Diffuser	Stainless Steel
7	Support Diffuser	Stainless Steel
8	Coupling	Stainless Steel
9	Impeller	Stainless Steel
10	Cylinder	Stainless Steel
11	Shaft	Stainless Steel
12	Intermediate Bearing	SiC / WC
13	Inducer	Stainless Steel
14	Inlet/Outlet Chamber	Stainless Steel / Ductile Cast Iron
15	Base	Ductile Cast Iron

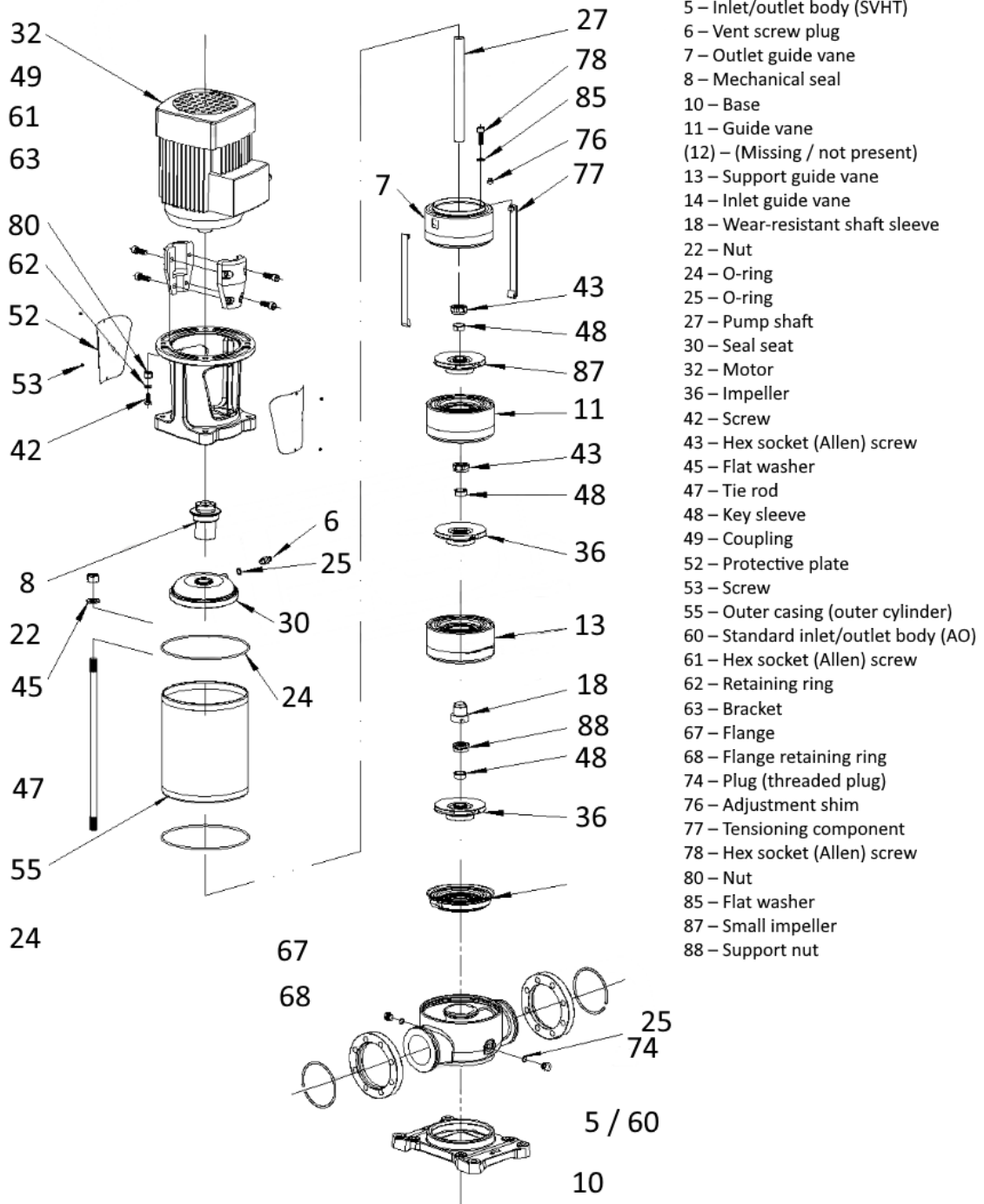

WARRANTY / CERTIFICATIONS

